

# Airplane. Rocket. CROSS!

## HOW TO GET TO HEAVEN

Explaining to children how we can get to heaven can be challenging. Use this resource as a helpful visual for them to understand the magnitude of the cross. This exercise will walk you through how to explain Jesus' life and death and how his resurrection means LIFE for the rest of us. There's even a special surprise at the end that will even shock adults!

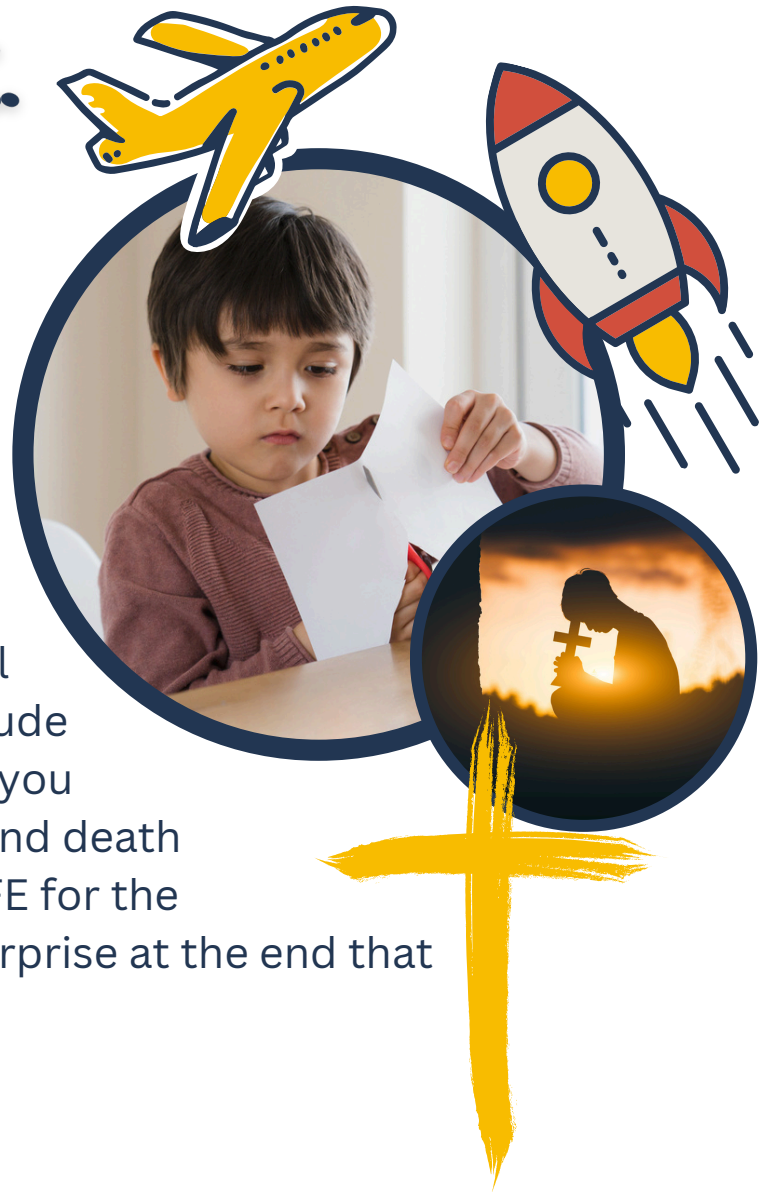

## MATERIALS NEEDED:

- 8.5 x 11 plain paper
- Rocket / Airplane / Cross Illustration (*included in this resource*)
- Bible

[www.bible2school.com](http://www.bible2school.com)

 @bible2school  @bible\_2\_school

**BIBLE**  **SCHOOL**<sup>®</sup>  
AT HOME 

## **INSTRUCTIONS & GUIDED CONVERSATION:**

Using the paper, make folds 1, 2, 3, and 4. Read John 11:25.

Say, *“We all know we will die here on earth. So, what do you think Jesus was talking about when he said we would live? Where would that be?”*

Allow your child to respond, then say *“Yes, in heaven!”*

Show the paper airplane. Ask, *“How far do you think you could go in an airplane? Could that take you to heaven?”*

Allow your child to respond, then say *“No, an airplane can’t take us to heaven.”*

Say, *“Maybe we need something more powerful.”* Tear the paper as indicated in step 5 (along the dotted line). Unfold one fold only.

Ask, *“How about a rocket? How far can we go in a rocket? Could that take us to heaven?”*

Allow your child to respond, then say *“No, a rocket can’t take us to heaven either.”*

Say, *“Maybe we need something even more powerful.”* Slide your finger up the back of the rocket to pop out the cross.

## **INSTRUCTIONS & GUIDED CONVERSATION (continued):**

Say, *“Jesus said ‘I am the resurrection and the life.’ It is only through believing in Jesus that we can be in heaven with him. Jesus died on a wooden cross shaped like this. In Jesus’ time, the cross was a form of punishment where you hung until you died. It was only used for the worst criminals. But Jesus wasn’t a criminal; he never sinned or did anything wrong at all. So why did Jesus die on a cross like this? He died as a substitute for our sins and bad choices. There is no sin in heaven, and since we’ve sinned, how can we be there?”*

*When Jesus was on the cross, he took all our sins on himself. When we believe and accept that he died for our sins, and ask for forgiveness from our sins, he takes those sins away and we can be in heaven with him and have life forever.”*

### **SPECIAL SURPRISE:**

Once you have the Cross, lay out the scraps to spell **“LIFE.”**

*“I am the resurrection and the life. Whoever believes in me, though he die, yet shall he live.”*

John 11:25

[www.bible2school.com](http://www.bible2school.com)

 @bible2school  @bible\_2\_school



# ROCKET / AIRPLANE / CROSS ILLUSTRATION

1.

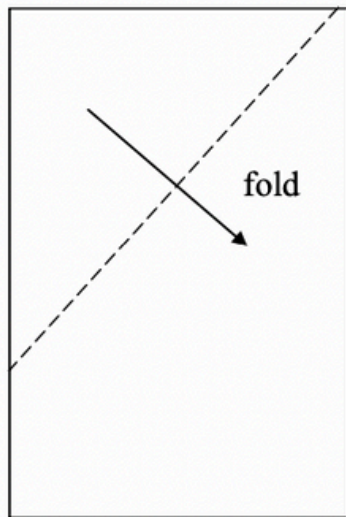

2.

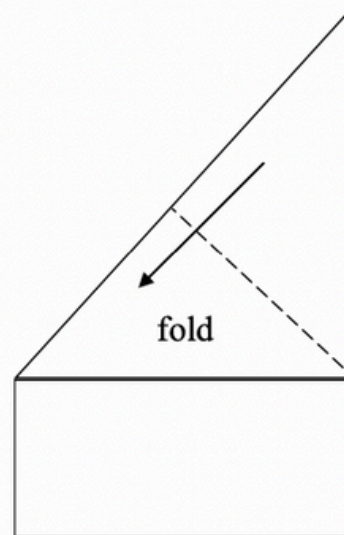

3.

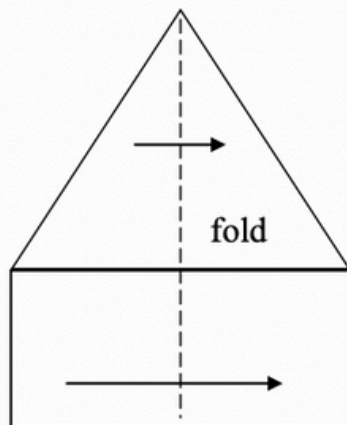

4.

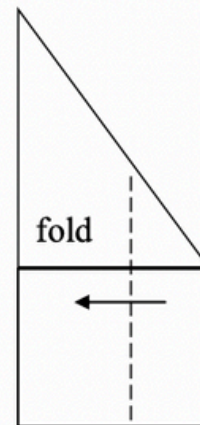

5.

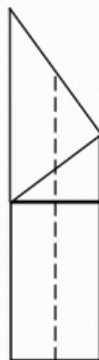

Tear along dotted line

Psalm 59:17



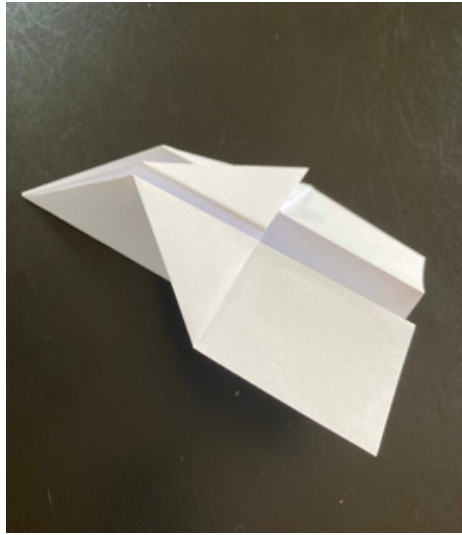
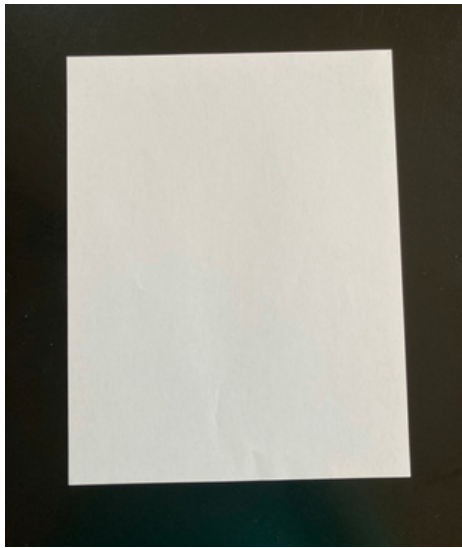

[www.bible2school.com](http://www.bible2school.com)

 @bible2school  @bible\_2\_school

